

IRG4BC30U-S

INSULATED GATE BIPOLAR TRANSISTOR

UltraFast Speed IGBT

Features

- UltraFast: Optimized for high operating frequencies 8-40 kHz in hard switching, >200 kHz in resonant mode
- Generation 4 IGBT design provides tighter parameter distribution and higher efficiency than Generation 3
- Industry standard D²Pak package

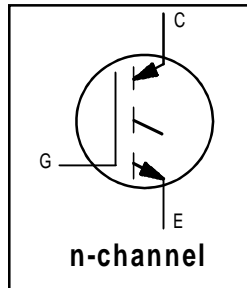

$V_{CES} = 600V$
$V_{CE(on)} \text{ typ.} = 1.95V$
@ $V_{GE} = 15V, I_C = 12A$

Benefits

- Generation 4 IGBT's offer highest efficiency available
- IGBT's optimized for specified application conditions
- Designed to be a "drop-in" replacement for equivalent industry-standard Generation 3 IR IGBT's

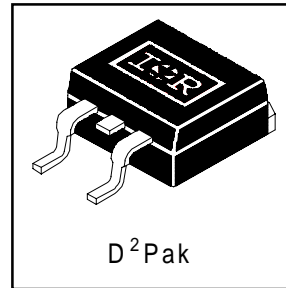

Absolute Maximum Ratings

	Parameter	Max.	Units
V_{CES}	Collector-to-Emitter Breakdown Voltage	600	V
$I_C @ T_C = 25^\circ C$	Continuous Collector Current	23	A
$I_C @ T_C = 100^\circ C$	Continuous Collector Current	12	
I_{CM}	Pulsed Collector Current ①	92	
I_{LM}	Clamped Inductive Load Current ②	92	
V_{GE}	Gate-to-Emitter Voltage	± 20	V
E_{ARV}	Reverse Voltage Avalanche Energy ③	10	mJ
$P_D @ T_C = 25^\circ C$	Maximum Power Dissipation	100	W
$P_D @ T_C = 100^\circ C$	Maximum Power Dissipation	42	
T_J T_{STG}	Operating Junction and Storage Temperature Range	-55 to + 150	

Thermal Resistance

	Parameter	Typ.	Max.	Units
$R_{\theta JC}$	Junction-to-Case	—	1.2	$^\circ C/W$
$R_{\theta JA}$	Junction-to-Ambient, (PCB Mounted, steady-state)*	—	40	

* When mounted on 1" square PCB (FR-4 or G-10 Material). For recommended footprint and soldering techniques refer to application note #AN-994.

Electrical Characteristics @ $T_J = 25^\circ\text{C}$ (unless otherwise specified)

	Parameter	Min.	Typ.	Max.	Units	Conditions
$V_{(BR)CES}$	Collector-to-Emitter Breakdown Voltage	600	—	—	V	$V_{GE} = 0V, I_C = 250\mu\text{A}$
$V_{(BR)ECS}$	Emitter-to-Collector Breakdown Voltage ^④	18	—	—	V	$V_{GE} = 0V, I_C = 1.0A$
$DV_{(BR)CES/DT_J}$	Temperature Coeff. of Breakdown Voltage	—	0.63	—	V/ $^\circ\text{C}$	$V_{GE} = 0V, I_C = 1.0mA$
$V_{CE(ON)}$	Collector-to-Emitter Saturation Voltage	—	1.95	2.1	V	$I_C = 12A$ $V_{GE} = 15V$ See Fig.2, 5
		—	2.52	—		
		—	2.09	—		
$V_{GE(th)}$	Gate Threshold Voltage	3.0	—	6.0		$V_{CE} = V_{GE}, I_C = 250\mu\text{A}$
$DV_{GE(th)/DT_J}$	Temperature Coeff. of Threshold Voltage	—	-13	—	mV/ $^\circ\text{C}$	$V_{CE} = V_{GE}, I_C = 250\mu\text{A}$
g_{fe}	Forward Transconductance ^⑤	3.1	8.6	—	S	$V_{CE} = 100V, I_C = 12A$
I_{CES}	Zero Gate Voltage Collector Current	—	—	250	μA	$V_{GE} = 0V, V_{CE} = 600V$
		—	—	2.0		$V_{GE} = 0V, V_{CE} = 10V, T_J = 25^\circ\text{C}$
		—	—	1000		$V_{GE} = 0V, V_{CE} = 600V, T_J = 150^\circ\text{C}$
I_{GES}	Gate-to-Emitter Leakage Current	—	—	± 100	nA	$V_{GE} = \pm 20V$

Switching Characteristics @ $T_J = 25^\circ\text{C}$ (unless otherwise specified)

	Parameter	Min.	Typ.	Max.	Units	Conditions
Q_g	Total Gate Charge (turn-on)	—	50	75	nC	$I_C = 12A$ $V_{CC} = 400V$ See Fig.8 $V_{GE} = 15V$
Q_{ge}	Gate - Emitter Charge (turn-on)	—	8.1	12		
Q_{gc}	Gate - Collector Charge (turn-on)	—	18	27		
$t_{d(on)}$	Turn-On Delay Time	—	17	—	ns	$T_J = 25^\circ\text{C}$ $I_C = 12A, V_{CC} = 480V$ $V_{GE} = 15V, R_G = 23\Omega$ Energy losses include "tail" See Fig. 10, 11, 13, 14
t_r	Rise Time	—	9.6	—		
$t_{d(off)}$	Turn-Off Delay Time	—	78	120		
t_f	Fall Time	—	97	150	mJ	See Fig. 13, 14
E_{on}	Turn-On Switching Loss	—	0.16	—		
E_{off}	Turn-Off Switching Loss	—	0.20	—		
E_{ts}	Total Switching Loss	—	0.36	0.50	ns	$T_J = 150^\circ\text{C},$ $I_C = 12A, V_{CC} = 480V$ $V_{GE} = 15V, R_G = 23\Omega$ Energy losses include "tail"
$t_{d(on)}$	Turn-On Delay Time	—	20	—		
t_r	Rise Time	—	13	—		
$t_{d(off)}$	Turn-Off Delay Time	—	180	—	mJ	See Fig. 13, 14
t_f	Fall Time	—	140	—		
E_{ts}	Total Switching Loss	—	0.73	—		
L_E	Internal Source Inductance	—	7.5	—	nH	Measured 5mm from package
C_{ies}	Input Capacitance	—	1100	—	pF	$V_{GE} = 0V$ $V_{CC} = 30V$ See Fig.7 $f = 1.0\text{MHz}$
C_{oes}	Output Capacitance	—	73	—		
C_{res}	Reverse Transfer Capacitance	—	14	—		

Notes:

- ① Repetitive rating; $V_{GE} = 20V$, pulse width limited by max. junction temperature. (See fig. 13b)
- ② $V_{CC} = 80\%(V_{CES}), V_{GE} = 20V, L = 10\mu\text{H}, R_G = 23\Omega,$ (See fig. 13a)
- ③ Repetitive rating; pulse width limited by maximum junction temperature.
- ④ Pulse width $\leq 80\mu\text{s}$; duty factor $\leq 0.1\%$.
- ⑤ Pulse width $5.0\mu\text{s}$, single shot.

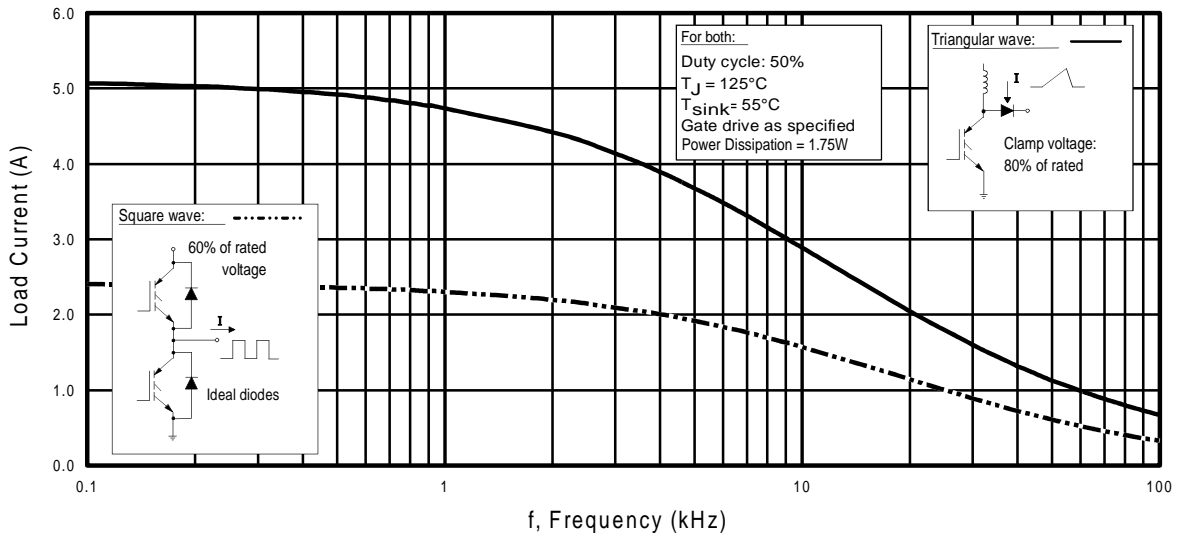

Fig. 1 - Typical Load Current vs. Frequency
(For square wave, $I = I_{RMS}$ of fundamental; for triangular wave, $I = I_{PK}$)

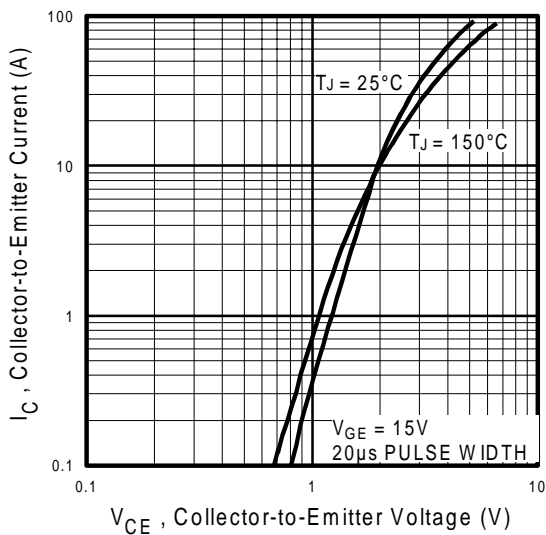

Fig. 2 - Typical Output Characteristics

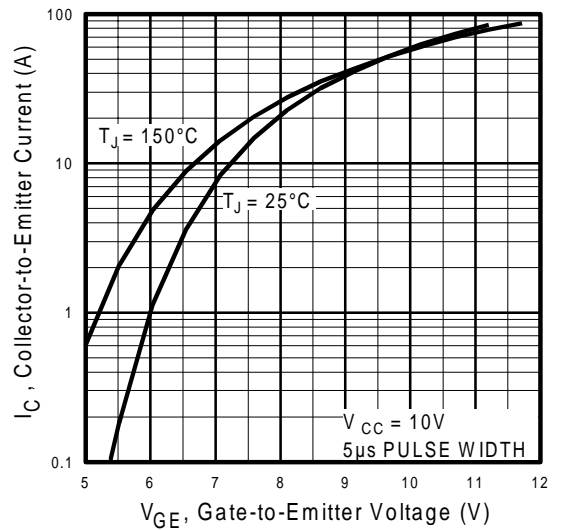

Fig. 3 - Typical Transfer Characteristics

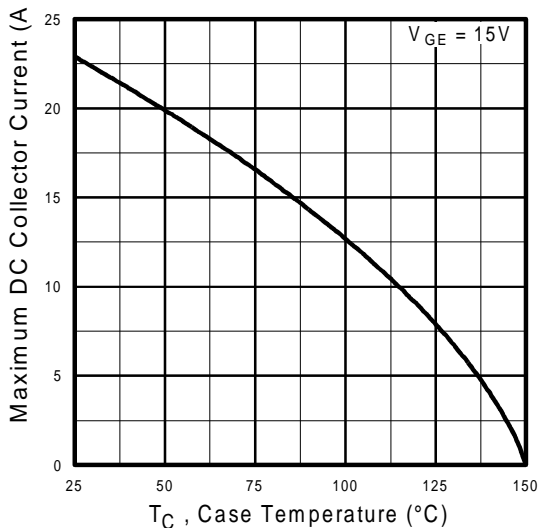

Fig. 4 - Maximum Collector Current vs. Case Temperature

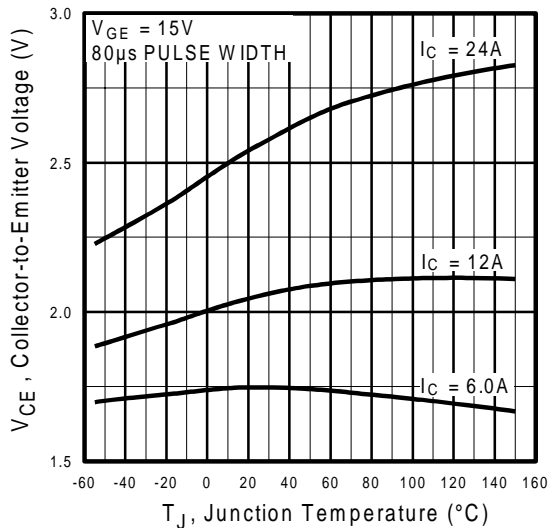

Fig. 5 - Collector-to-Emitter Voltage vs. Junction Temperature

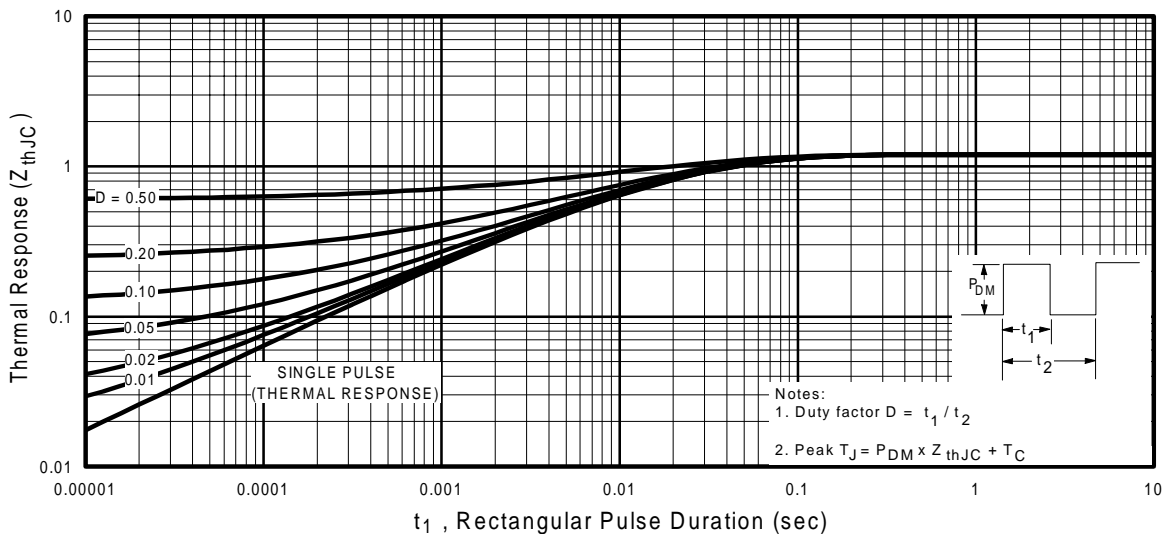

Fig. 6 - Maximum Effective Transient Thermal Impedance, Junction-to-Case

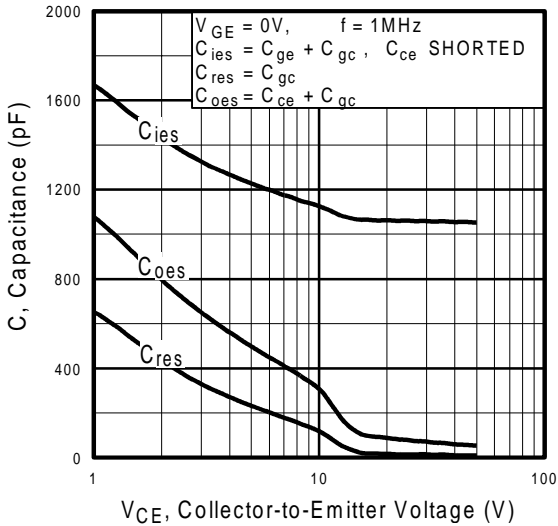

Fig. 7 - Typical Capacitance vs. Collector-to-Emitter Voltage

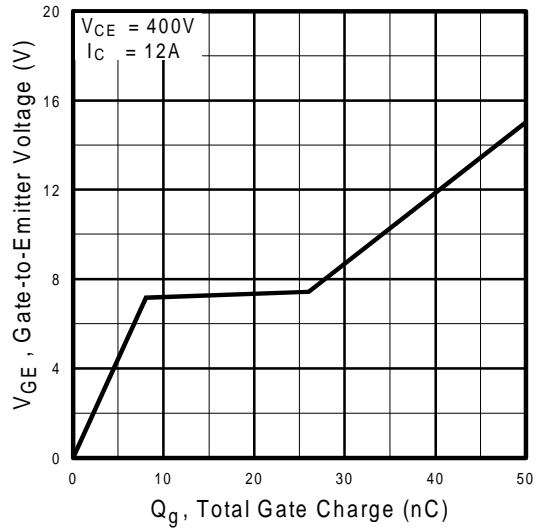

Fig. 8 - Typical Gate Charge vs. Gate-to-Emitter Voltage

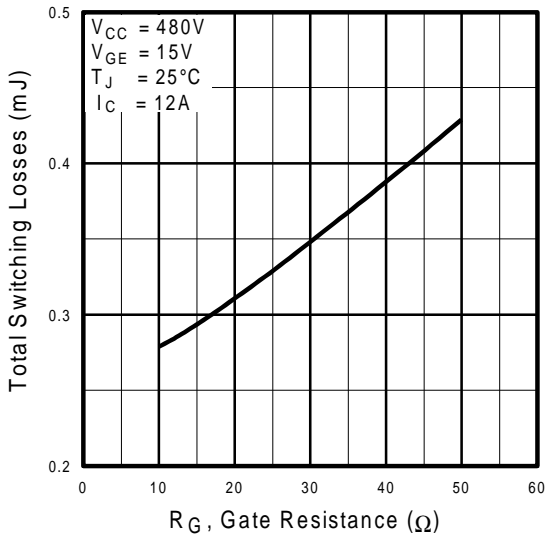

Fig. 9 - Typical Switching Losses vs. Gate Resistance

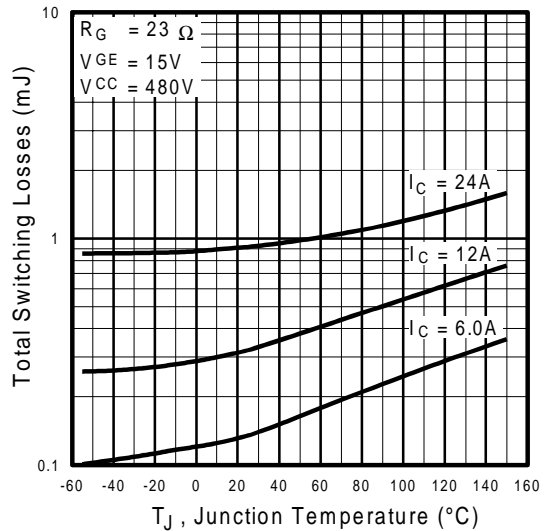

Fig. 10 - Typical Switching Losses vs. Junction Temperature

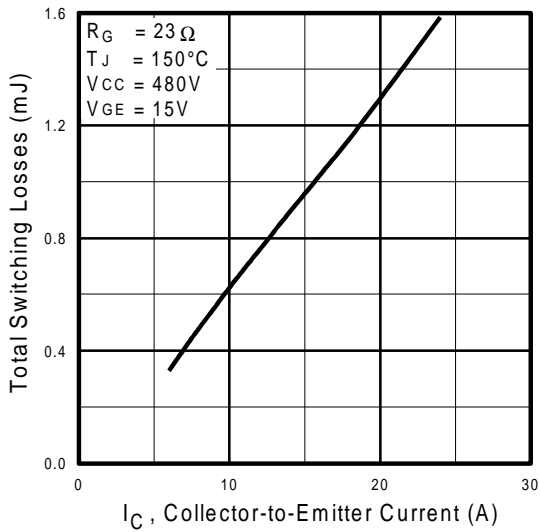

Fig. 11 - Typical Switching Losses vs. Collector-to-Emitter Current

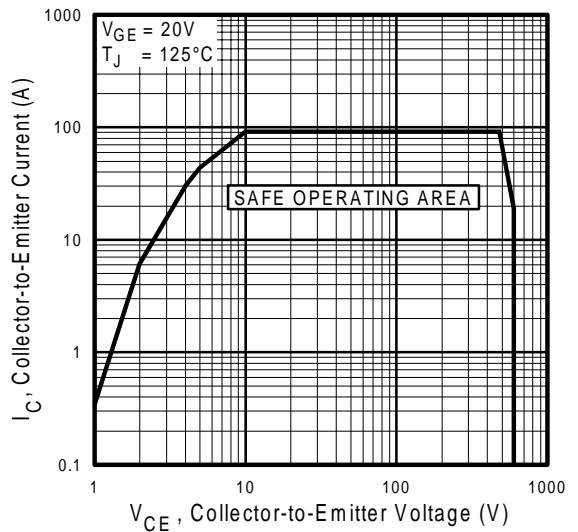

Fig. 12 - Turn-Off SOA

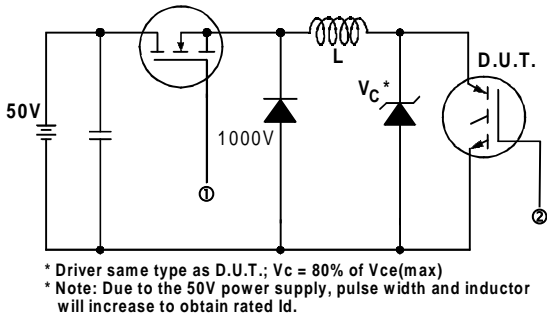

Fig. 13a - Clamped Inductive Load Test Circuit

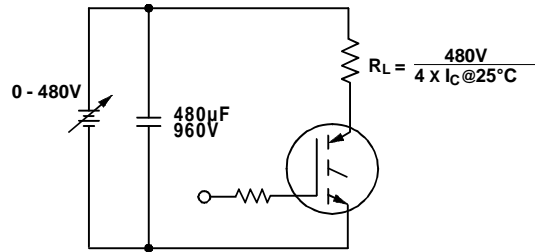

Fig. 13b - Pulsed Collector Current Test Circuit

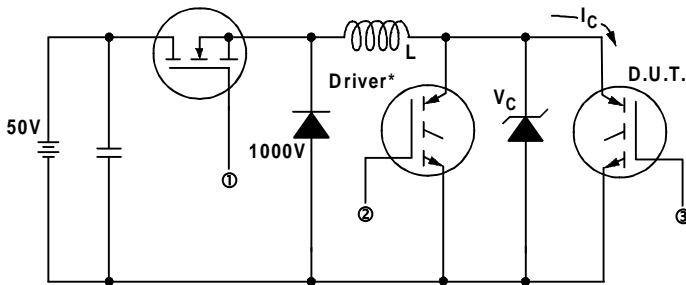

Fig. 14a - Switching Loss Test Circuit

* Driver same type as D.U.T., $V_C = 480V$

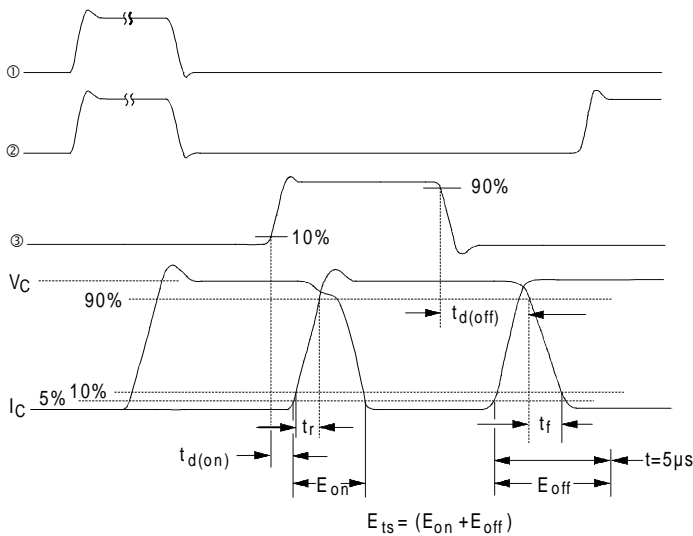
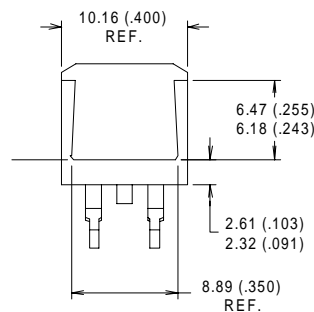
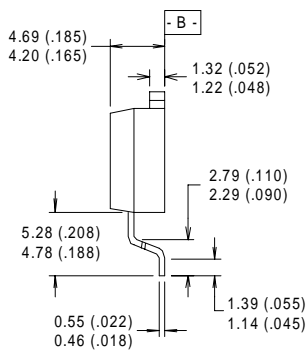
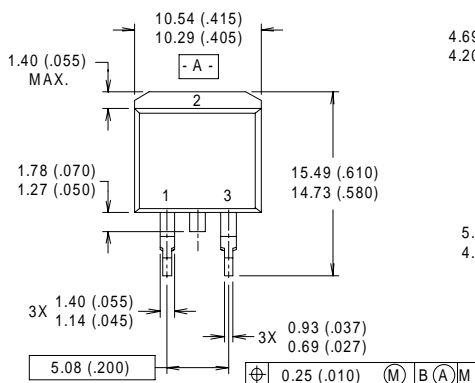
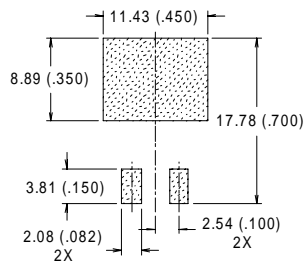

Fig. 14b - Switching Loss Waveforms

D²Pak Package Outline



MINIMUM RECOMMENDED FOOTPRINT



NOTES:

- 1 DIMENSIONS AFTER SOLDER DIP.
- 2 DIMENSIONING & TOLERANCING PER ANSI Y14.5M, 1982.
- 3 CONTROLLING DIMENSION : INCH.
- 4 HEATSINK & LEAD DIMENSIONS DO NOT INCLUDE BURRS.

LEAD ASSIGNMENTS

- 1 - GATE
- 2 - DRAIN
- 3 - SOURCE

Note: For the most current drawings please refer to the IR website at:
<http://www.irf.com/package/>